

Intro



1.Feature and Function

DigiMaster-III is the third generation multi-functional Automobile data adjusting equipment developed by Nanning Yanhua Electronics Co., Ltd. It bases on a high performance hardware platform which takes high-speed CPLD and the ARM11 processor as the core device. Seven inch LCD touch-screen with high resolution makes its interface easy-used. Working with various types of adapter you can easily achieve odometer correction. Audio

decoding, airbag resetting, engine ECU resetting, IMMO, programming key for Benz and BMW etc. It is applicative for all types of data processing such as OBD connection, dashboard soldering, CAS-BDM.

It contains the advanced technology of programming new keys for BMW and Benz, CAS-BDM reading/writing and resetting, 35080V6 erasure etc. The operation interface is highly user friendly, large numbers of pictures and particular description makes your operation pleasant. Online updating and module authorization keeps you always on the leading edge of technology.

2.Connector Instruction

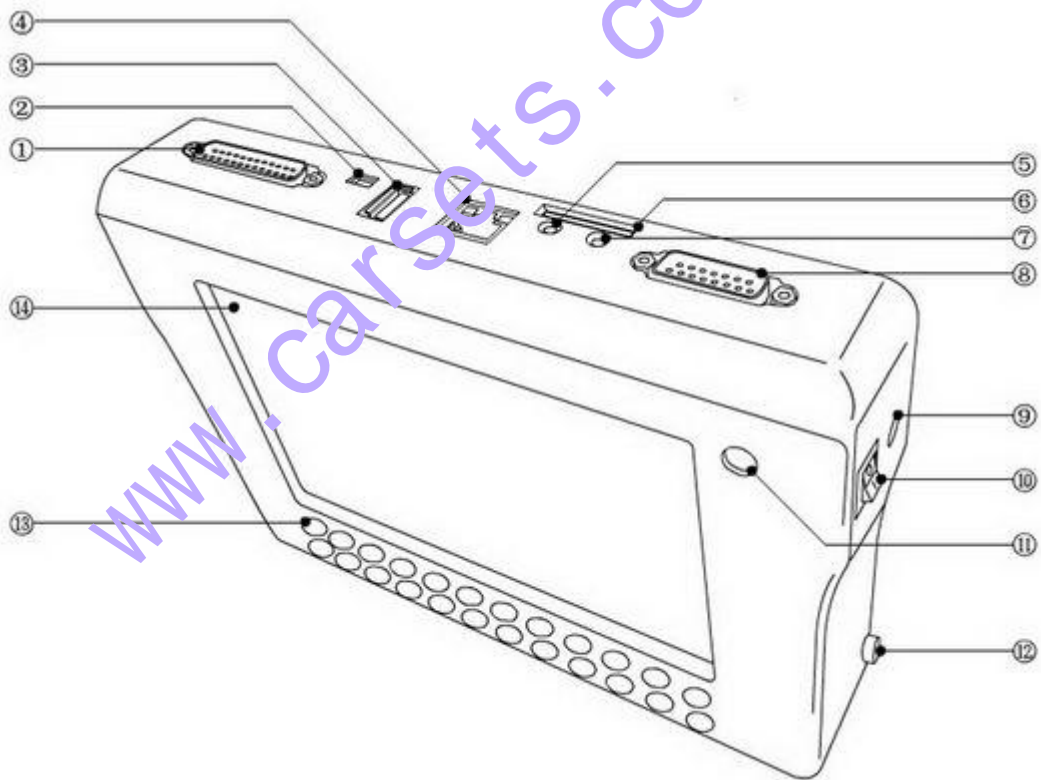

1	25 Pin adapter connector	8	15 Pin adapter connector
2	Mini USB Connector	9	Power adapter
3	USB Mouse Connector	10	switch
4	RJ45 LAN Connector	11	Power Indicator Light
5	Earphone Connector	12	Touch-Pen Connector
6	SD Card Connector	13	Keyboard
7	Microphone Connector	14	7 Inch LCD Touch-screen

¡°¼ü!ÄÜëµÃ÷£°

Keystroke	Function Instruction	
F1	Backspace	
keyboard	open/close soft-keyboard	
ESC	ESC	
OK	Enter	



The device will become Dormancy with black screen if no operation after XX minutes. Please click the screen to active it.

3.Adapter List

Product Name
OBP Adapter
ICP Adapter
NEC Adapter
NEC 14-PIN cable
W203/W220 Adapter
TMS370 Programmer
MCU Adapter
K&CAN Adapter
CAN-OBD DMI
VW AUDI OBDII
BENZ 38PIN
BENZ OBD
BMW E36
BMW E36 Meter Socket Connecting Cable
BMW E38/39
BENZ 95S
JAGUAR11DU
C/E CLASS
Ford Ranger
9S12 Adapter
Lexus LS400 Adapter
Grand Cherokee Adapter
W211 Adapter

E65/E66 Adapter
CAN&BDM Programmer
BMW CAN Adapter
MC705-PROG Adapter
MC711-PROG Adapter
NEC KEY
MC705E6
CAS OBD II
NXP
IAR key
ESL
29FXX

Software Installation

This section will show you how to install software of DigiMasterIII as well as how to connect it with your PC.

1.Installing D3 Tool

Step 1: Double-click the installation files in the CD.

Step 2: Choose the route of Installation



Step 3: Open the software interface as below after installation



2.Connect the D3 with PC and internet

Step 1: Connect the D3 USB with PC. Click "Cancel" after the window bombed as below.



Step 2: Click "OK" to close the bombed warning dialog.

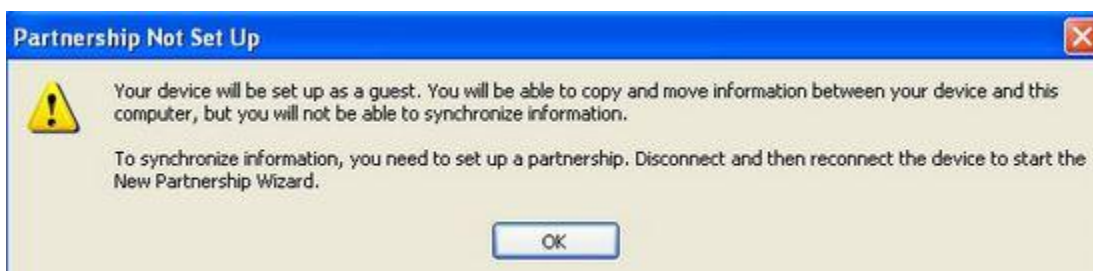

Step 3: The below window will appear after successful connecting with device.

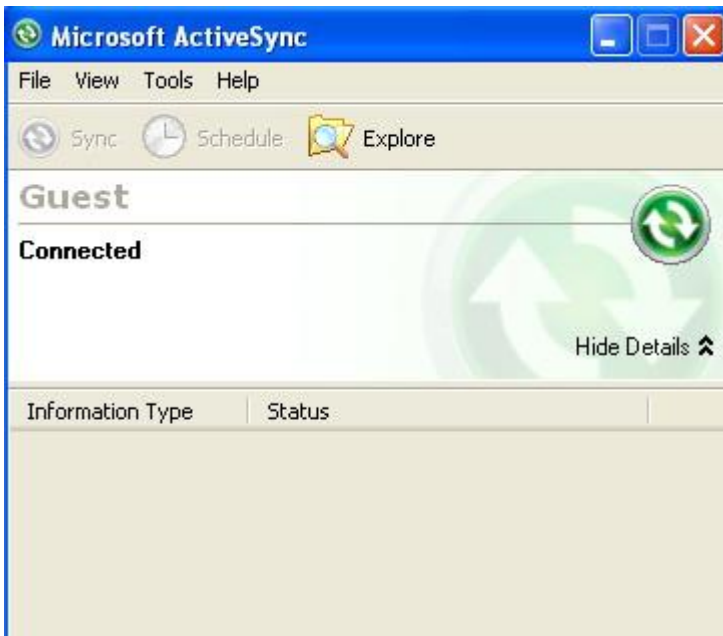

Step 4; Just reconnect the USB cable if the USB connecting is cut showed as below window.

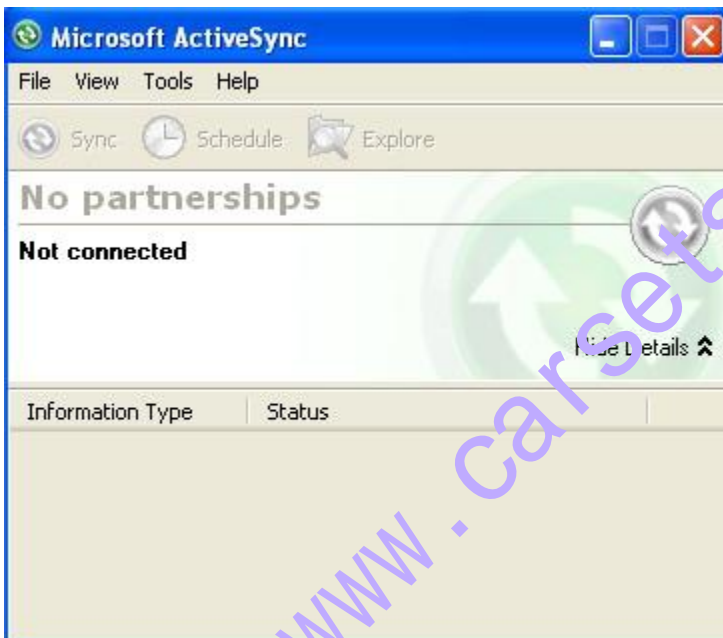

Insert the connector of LAN cable into RJ45 LAN connector of D3 to make online update.

3.Remote Assistance

Our engineers will provide you on-line technology support via internet when you choose long-distance assistance function.

Step 1: Please contact the Sales from my company to obtain an IP before the Remote Assistance. Then connect your D3 with internet.

Step 2: Open D3 Tool software to enter "Remote Assistance", then choose "Require Remote Assistance".



Step 3: Input the obtained IP and click "OK" in the bombed window;£

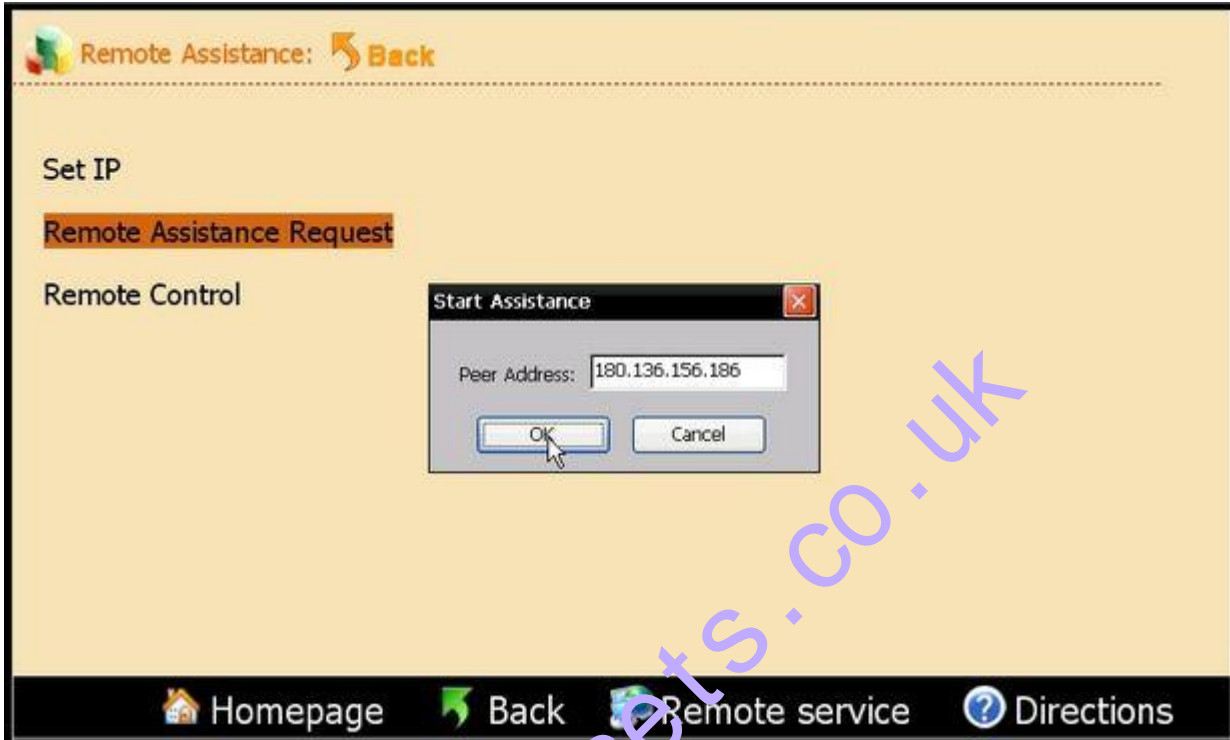

4. Kernel renovation

 Please don't try easily because Kernel Renovation being hazardous. Normally it is used on the useless because of the lose of kernel.

Step 1; Click keystroke "8" and "OK" together, then power on. The indication of "Press OK to continue and ESC to cancel" will appear on the screen. Press "OK" into Renovation.

Step 2: "Found new hardware" is found in the system when you connect USB cable with the PC.

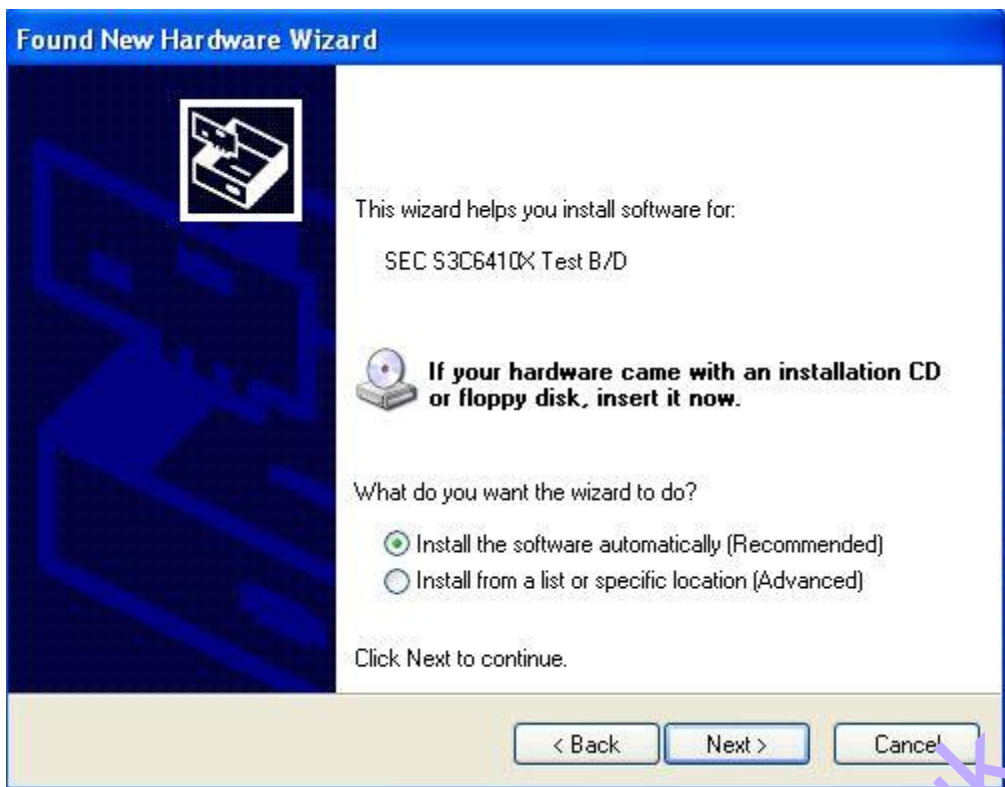

Step 3: Choose "Install software automatically", Click "next".

Step 4: Running D3 tool software, choose "KERNEL update"

Step 5: Indication "USB connect successfully" will appear as below after the USB is connected.

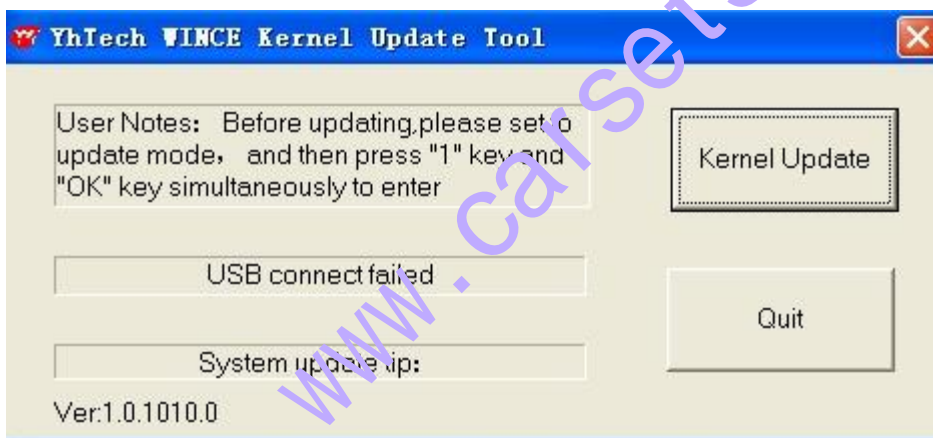

Step 6: Click "KernelUpdate", choose kernel files, then click "OK" to start renovation.

Step 7: Several minutes is need for kernel renovation. It is finished when the indication of "USB connect failed" appear.

Easy Operation Manual

Helping you checking accessories £→complete the activation £→authorization and updating.



Programmer



Audio Decoding



Meter System



IMMO



Airbag Resetting



ECU



Management



Directions

Version: 1.7.1102.10

1.Activation

Digimaster-III need to be activated on line with the Activation code provided by us in the first using. You can activate and recharge Digimaster-III by the following steps.

Step 1: Power on and connect the D3 with internet. The unactivated D3 show as below. Click "OK" to start activation.



Step 2: Input the validation code in the left dialog, Click "next" to download update programme and management programme.



Step 3: Activation window will appear after downloading Management programme. Please input your information



Step4 Enter the activation code and password provided by sales then click "next".



2.Payment

Step 1: Recharge dialog will appear after D3 activation in the first use. If no, click "Payment" in "management center" to start recharging.



Step 2: Input the Recharging code and password provide by the sales. Click "Next".



Step 3; Click "Finish" to finish the recharging after reminding of successful Payment appear.

3.Upgrade

We provide frequent upgrade of software & hardware programme,new vehicle models or amend hole in order to improve the functions of Digimaster-III. Please note the upgrade affiche in our website <http://www.autoemaster.com/en/>

Step 1; Click "Software upgrade" to find new upgrade. Input the Validation code in the dialog to start download and upgrade.



Step 2; It will remind you whether you need adapter upgrade after software update. Click "YES" to start adapter upgrade; Click "NO" to next step.(No need to upgrade adapter frequently)



Step 3; Enter the verify code and click next. The D3 will restart automatically after software upgrade.



Operation sample

In This section, we use a specific car as an example to elucidate the entire proceeding of odometer correction?Audio decoding?airbag resetting?Controlling ECU resetting?IMMO, programming key for Benz and BMW etc.

1.Programmer



1.1 Files Operation

You will find the following interface during many operations(IC programming, CPU programming,Odometer adjusting,Audio decoding). It show the current data read from the IC by HEX format. You can adjust or save the data in this interface.

HEX address is in the left column. Data area is in the right column. Data ASCII display is in the bottom when you move the scroll bar.



item	function
ReadData	Read data from device
SaveData	Save data file to SD card
WriteData	Write data into device
DackData	Import data to device
ModifyData	shift to modify modle
Close	Exit

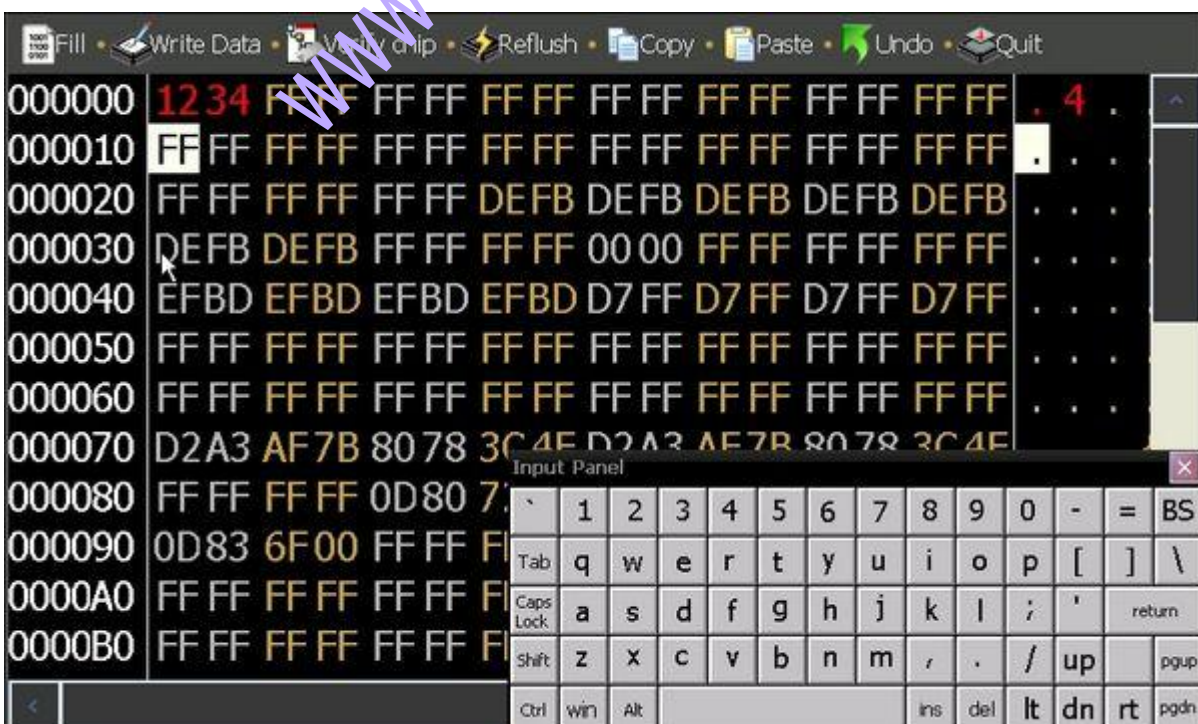

item	function
Fill	Fill a section address with data
WriteData	Write data into device
VerifyChip	Verify data to find if WriteData successful
Reflush	Reflush device with all FF
Copy	Copy a slice of data
Paste	Paste data
Undo	Cancel the previous action
Quit	Return to data interface

1.2 IC Programming

Step 1: Connect the chip De-solder or link the chip to the OBP adapter according to the instruction.

Please select the type of chip: (See the Help) Back

Usual series

24C01	24C64	25170	89102	93LC46	95320	CXK1011P	non-standard 93C46
24C01A	24C128	25320	93C06	93LC56	95P01	D6253	M35080 Series
24C02	24C256	25640	93C14	93LC66	95P02	D6254	B58(BOSCH)
24C02A	25010	3132	93C46	93LC86	95P04	S130	
24C04	25020	35080	93C56	95010	95P08	S220	
24C08	25040	59C11	93C65	95020	97101	ST14771	
24C16	25043	68343	93C76	95040	X5043	PDH004	
24C17	25045	85C72	93C86	95080	X5045	X25043	
24C32	25080	85C82	93CS56	95128	C46M6	B58252	

Homepage Back Remote service Directions

Step 2: Choose the corresponding chip in this interface to begin read or program the chip.



1.3 CPU Programming

Step 1: Connect the chip De-solder or link the chip to the OBP adapter according to the instruction.



Step 2: Choose the corresponding chip in this interface to begin read or program the chip.



1.4 Signal Generator

Frequency signal generator can generate the specified speed signal, connect to the signal pin in the odometer and then used to run the odometer.

2.Audio decoding

When the vehicle audio was power off because of battery damage, the audio will start the anti-theft system automatically. Digimaster III can calculate the audio code out or initialize the it.

www.carsets.co.uk

Please select the audio decoding auto series: (See the Help) [Back](#)

Alfa	Audi	Benz	BMW
Ford	GM	Honda	Lexus
Mazda	Mitsubishi	Peugeot	Porsche
Renault	Toyota	Volvo	Volkswagen
Other	Address	BMW TV-free	

[Homepage](#)
[Back](#)
[Remote service](#)
[Directions](#)

DigiMaster

Programmer	Audio Decoding	Water System	IMMO
Airbag Resetting	ECU	Management	Directions

2.2 Audio Code Management

Step 1: De-solder the corresponding chip according to the software prompts. Click "Next" to begin decoding.

Please select the audio decoding auto series: (See the Help) [Back](#)

Alfa	Audi	Benz	BMW
Ford	GM	Honda	Lexus
Mazda	Mitsubishi	Peugeot	Porsche
Renault	Toyota	Volvo	Volkswagen
Other	Address	BMW TV-free	

[Homepage](#)
[Back](#)
[Remote service](#)
[Directions](#)

Step 2: Please remember the code in the pop-up dialogue box, click "Next", the code was written in the chip.

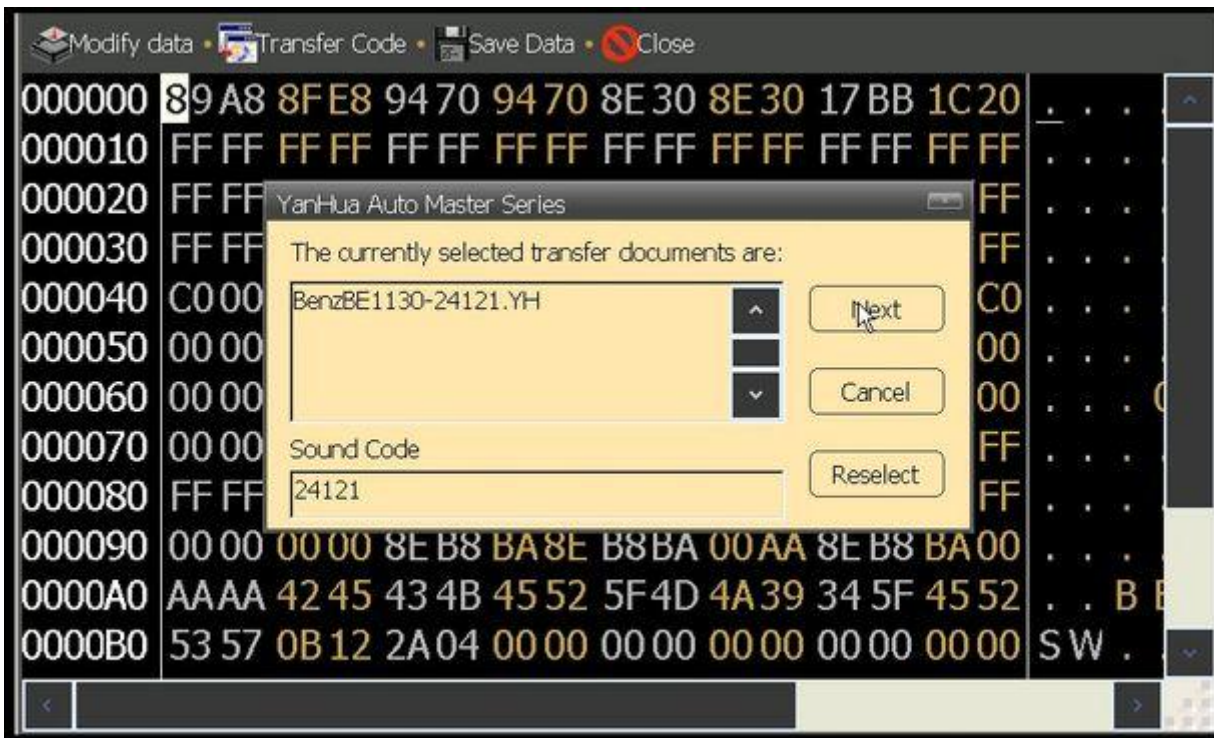

Step 3: Solder the chip back to the board, and then use this new code to decode the audio.

2.3 Address Code

These models only need to short-circuit some welding spot to reset the code, the software will give a specific method.

www.carsets.co.uk

3.Meter System

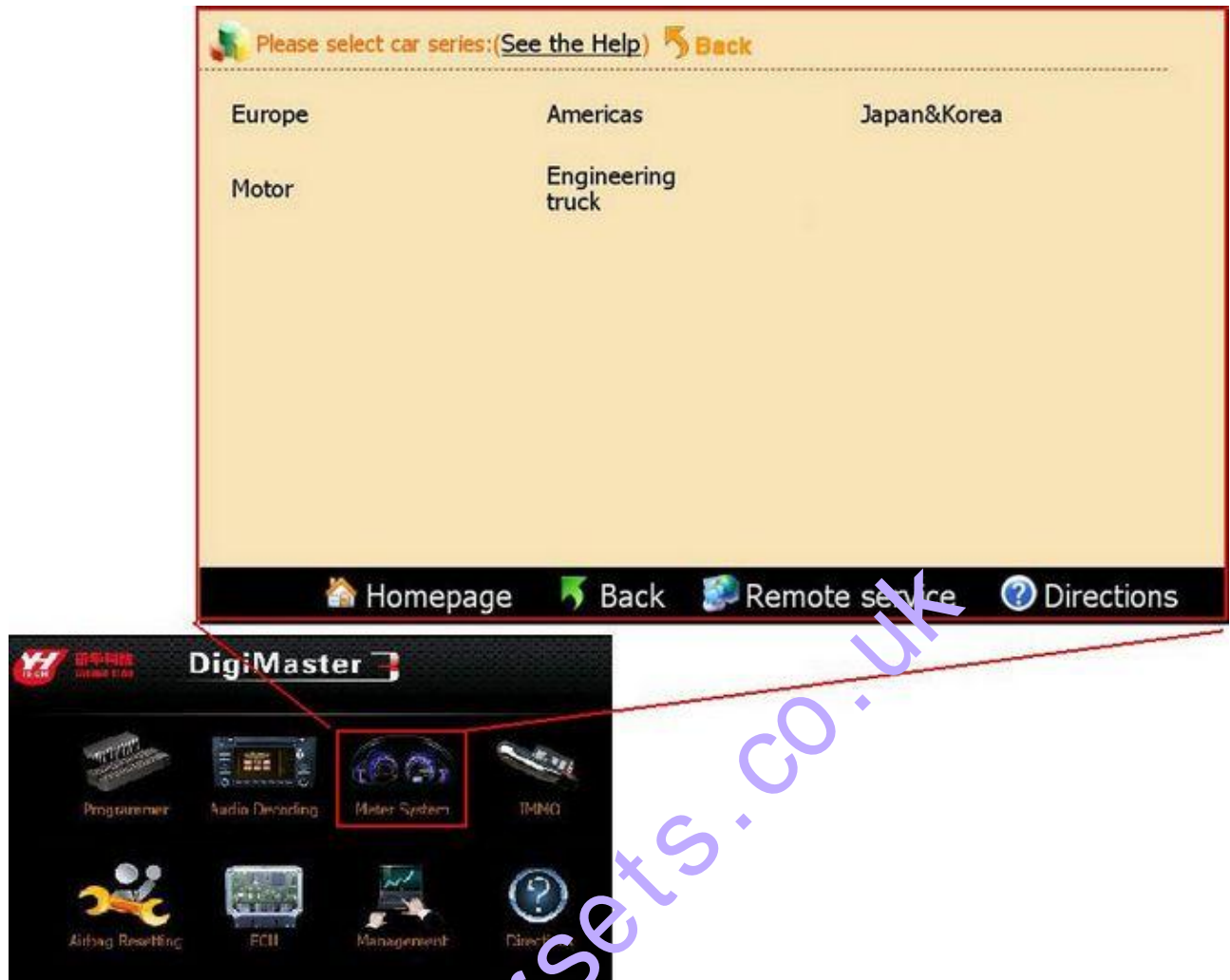

3.2 IC Adjusting

De-solder the chip from the odometer, and solder it back after adjusted.



To make sure the data was safe, please save the original data before change it by yourself.

Step 1: Click on "Odo adjuster" on the homepage, and then choose the car model of the odometer. For example: American vehicles- Chrysler.



Step 2: Take Dodge Ram for example, de-solder the memory chip on the odometer board, and solder the chip to the OBP adapter.



Step 3: Save the data and enter the expected mileage.

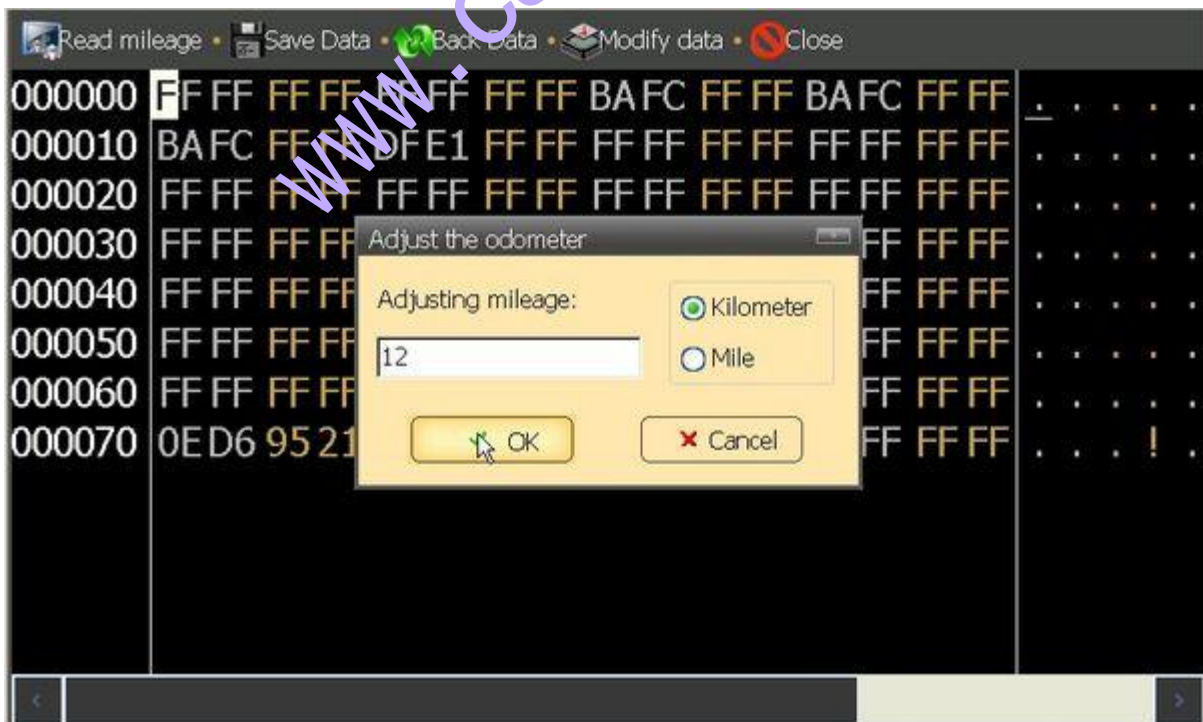

Step 4: After it prompted succeed, click on "Exit". Solder the chip back to the odometer.

3.3 ICP Adjusting

Step 1: Take American vehicles- Chrysler- 300K for example: Choose "Program BCM module", solder the wires to the welding spot of the odometer, then click "Next"



Step 2: Save the data and enter the expected mileage.

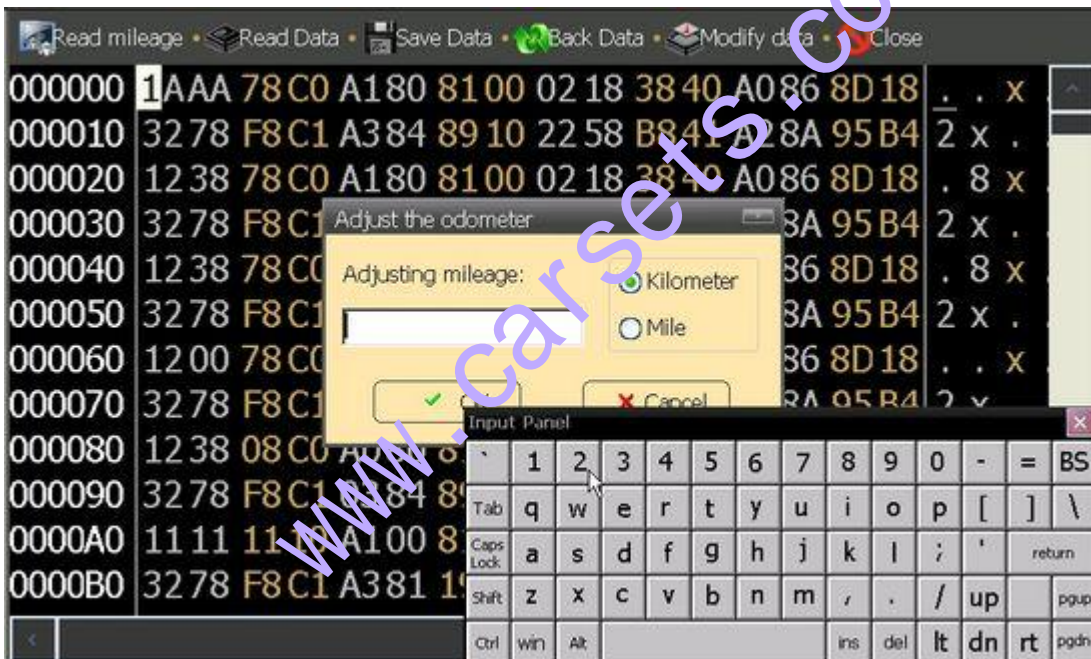

Step 3: After it prompted succeed, click on "close". De-solder the wires off the odometer.

3.4 OBD Adjusting

Step 1: Take European Vehicles- VW for example, choose "Diagnosis". In this page it list all the models that can be adjusted via OBD way, here we choose "Autodetect", it can identify the car model automatically.

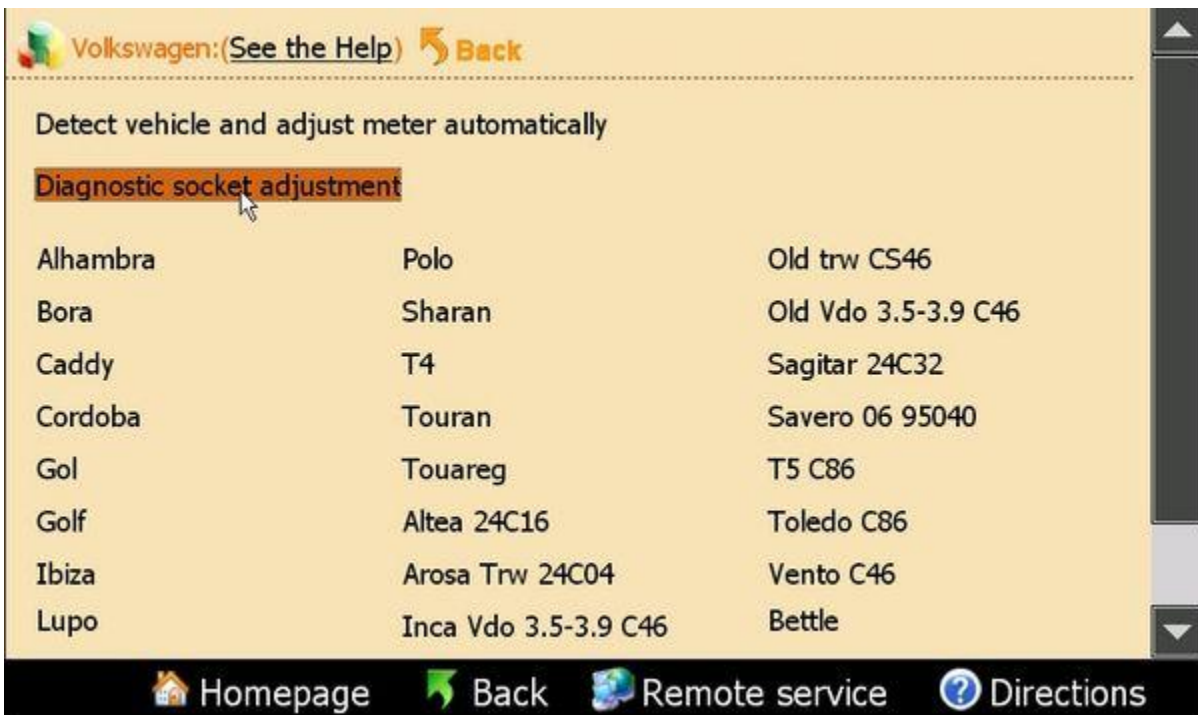

Step 2: Check the outfit of the cable, insert the OBD cable to the Diagnosis port, click "Next".

Step 3: enter the expected mileage.



4. Anti-Theft System

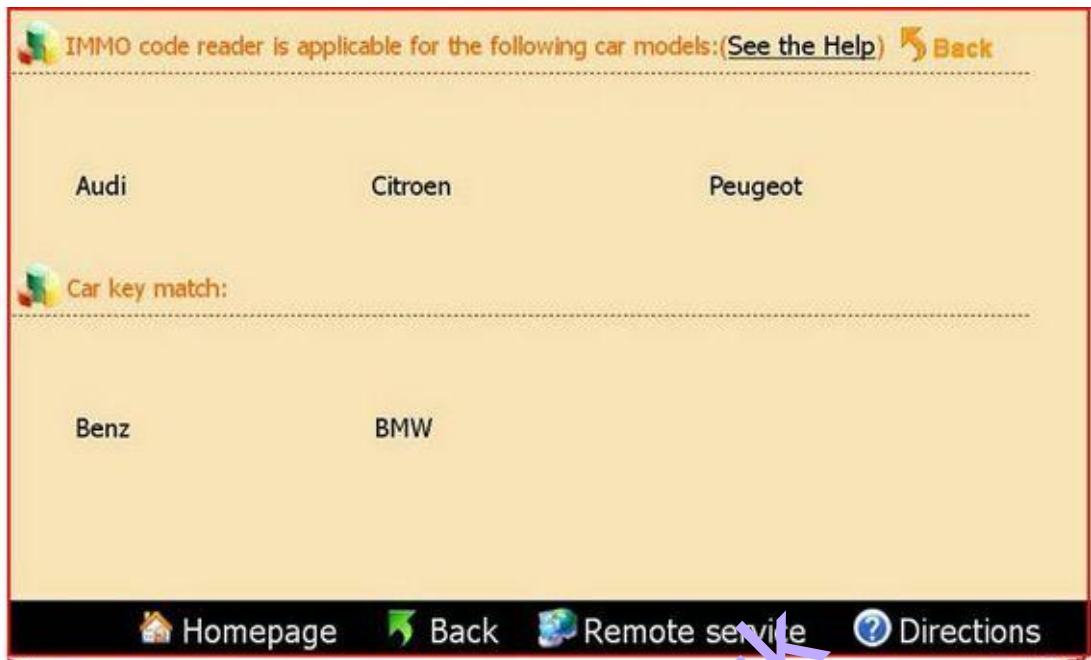

This function can be divided into two parts: Anti-theft code reading (VW, Citroen and Peugeot) and program keys for BMW and Mercedes Benz.



Features of some adapters.

Adapter Name	Feature
9S12 Adapter	
OBD Adapter	
CAN Adapter	
CAS-OBD Adapter	

4.1 Anti theft Code Reading

Step 1: Click "Anti-theft System" on the Homepage, and choose the vehicle model of the anti-theft device. Take "VW- AUDI - New Passat" for example.



Step 2: Find the chip on the circuit board according to the instruction(e.g.93C86), remember the chip direction and solder it off, weld it on the adapter and then click "Next".



Step 3: The anti-theft code will be shown in the dialogue box.



4.2 Key Binding

YH Key Binding:

The BZ-KEY and BM-KEY produced by our company can only be programmed by our key programmer (This key programmer also support original key programming), therefore, you need to bind the keys to the programmer before using them.

About "Use the last data"

Suitable for the last data: If you are using Automatic mode, and the operation was stop accidentally, you can use the recorded data and begin with the last step, do not need to start all over again.

Key Binding Steps:

To download the bond key information to the device key list.

Step 1: Click ""Key Register" in Management Center.



Step 2: Enter the verification code into the pop-up Dialogue box.



Step 3: The device will download update to your key list.



About Automatic mode, Advanced mode and Special mode.

Key programming can be done by Automatic mode and Advanced mode. The results of both methods are the same and the process is also similar, the only difference is: when in advanced mode, you can use you own data (bin format or other YH format), skip some steps to save time and tokens. Special mode suitable for BMW using two keys in one key channel.

4.3 Mercedes Benz Key Programming

Step 1: Go to the Mercedes Benz: Key programming page.

Step 2: Take S Class W220 as example, click "S Class", choose Automatic mode, you will see there are 3 steps to program the key for Benz W220.



Step 3: First step, program EIS, choose 05X32/1D69J to enter the following page.

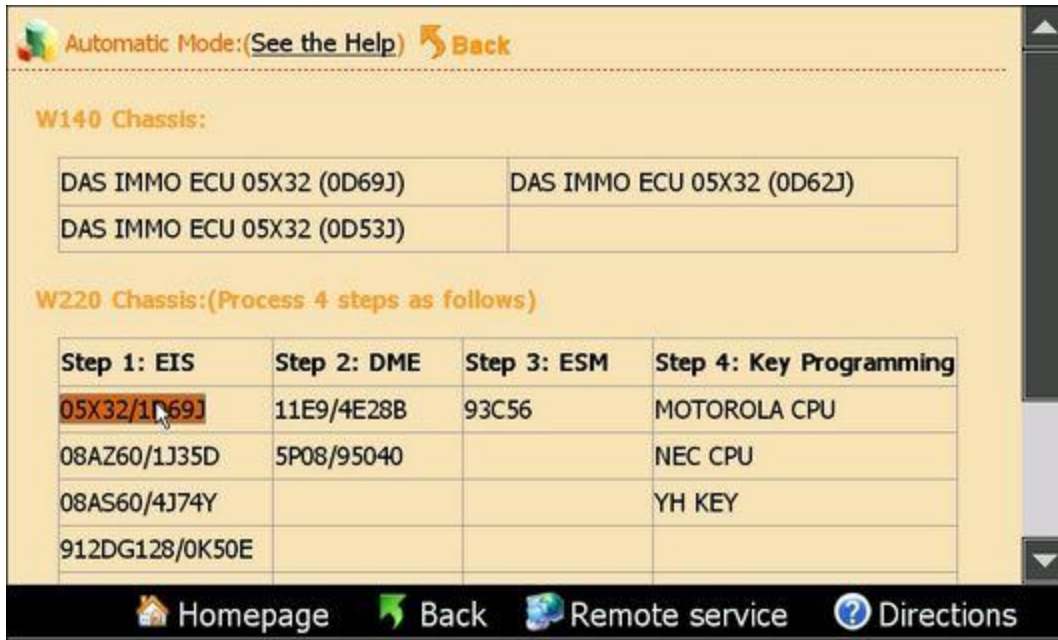

Step 4: De-solder the two CPU according to the diagram, and solder them to the adapters. (to avoid mix up please mark the two CPU before taking them off)



Step 5: After read the data it will show the SSID information etc. Choose the key number you want and then click "Write data" to finish the EIS adjust.

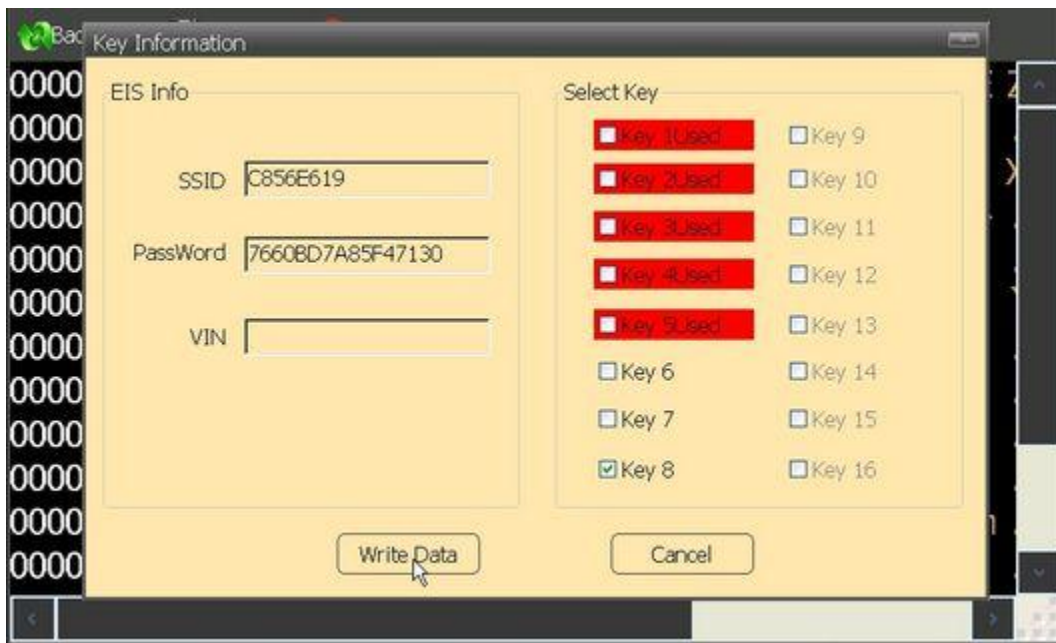

Step 6: step 2, DME. Take 95040 for example, check the picture and remove the clip to the adapter, click "Next".



Step 7: After read the data, it will show the ECU information, click "Write data" to finish the ECU programming.

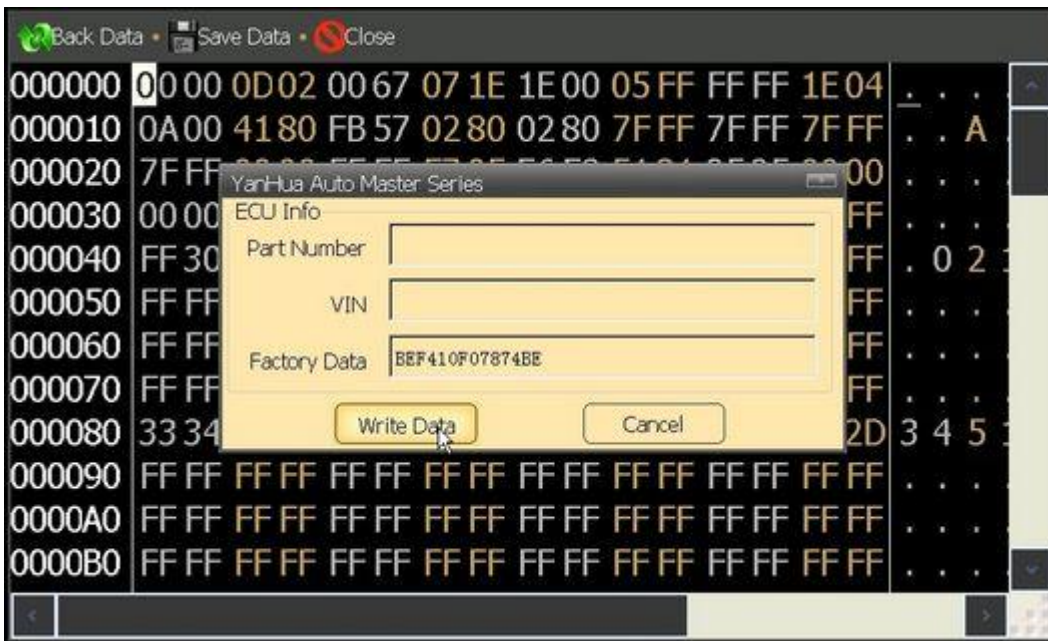

Step 8: Step 3, ESL. Check the picture and remove the chip to the adapter, click "Next".



Step 8: click "Write data" to finish this step.



Step 9: Step 4, key programming (this step is based on the data of step 1, if not implemented "Step 1" , this step can not be operated). Take YH Key for example. Before program the YH Key please make sure it was registered.



Step 10: Choose the key No. to begin key programming.

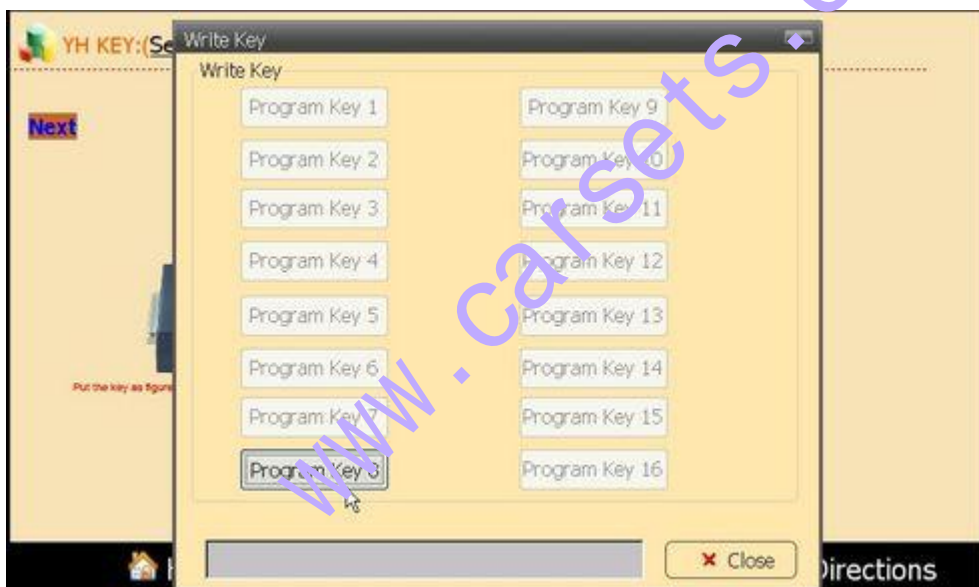

4.4 BMW Key Programming

Step 1: Go to the BMW Key programming page.

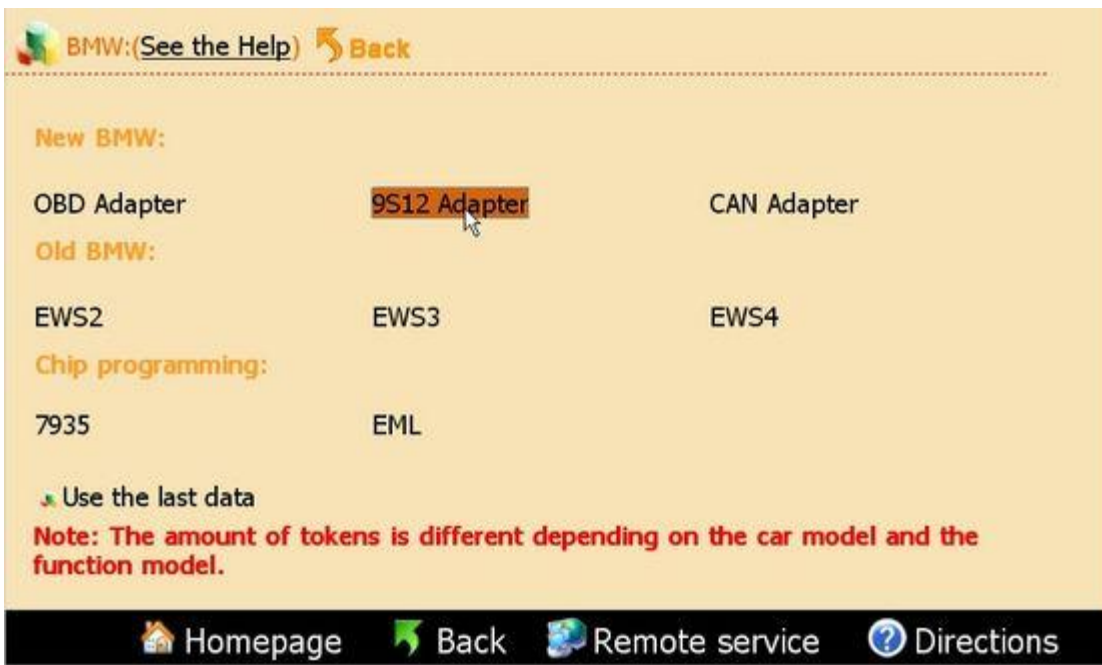

Step 2: Take "9S12 Adapter - Automatic mode - CAS2 1 Series White shell CAS" for example.



Step 3: Click "Step 1: CAS Reading". After read the data the following interface come up, the red key No. has been used. Choose the Key No. you want and click "Next" to finish the first step.



Step 4: Choose "Step 2: Key programming". Place the key in the slot of the adapter. (If the key is YH Key please make sure it was registered before programming). Click "Next". The pop-up dialogue will show the information of the current key.

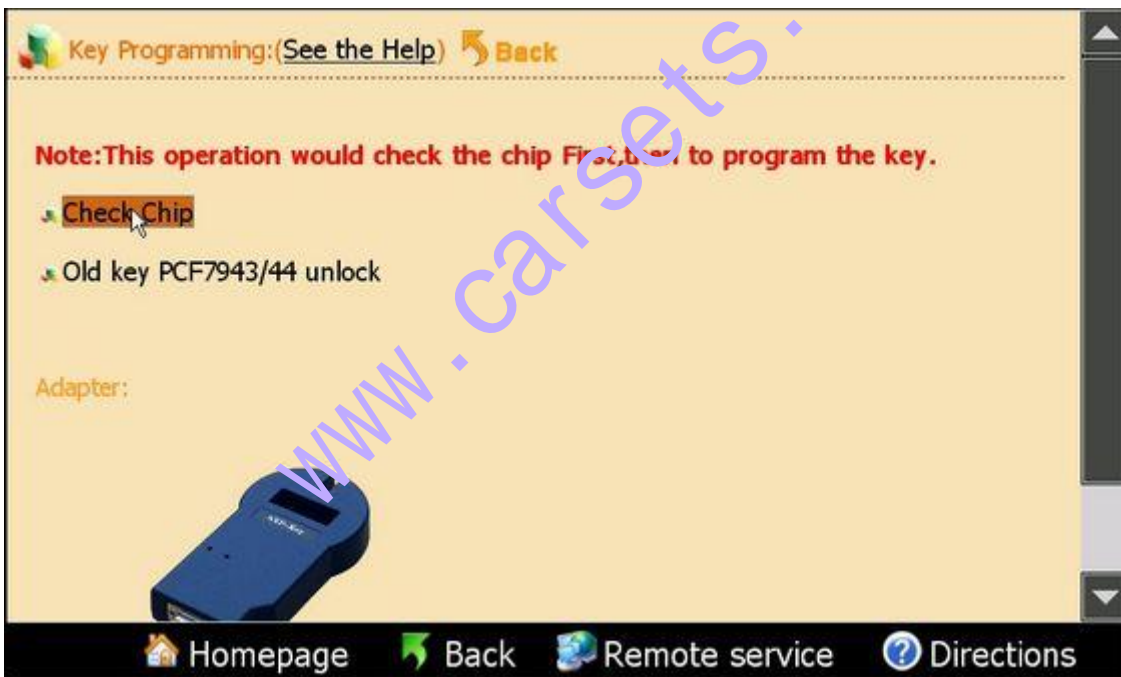

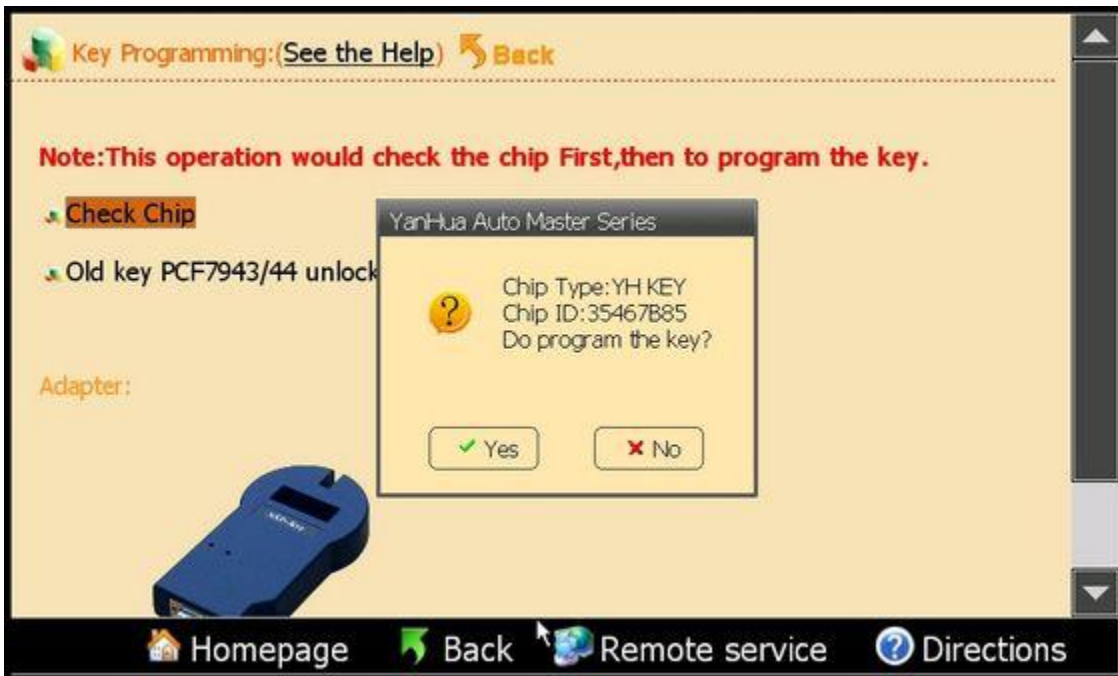

Step 5: Choose the Key No. you want to program, it will pop-up the tokens dialog box, click "Next" to continue.

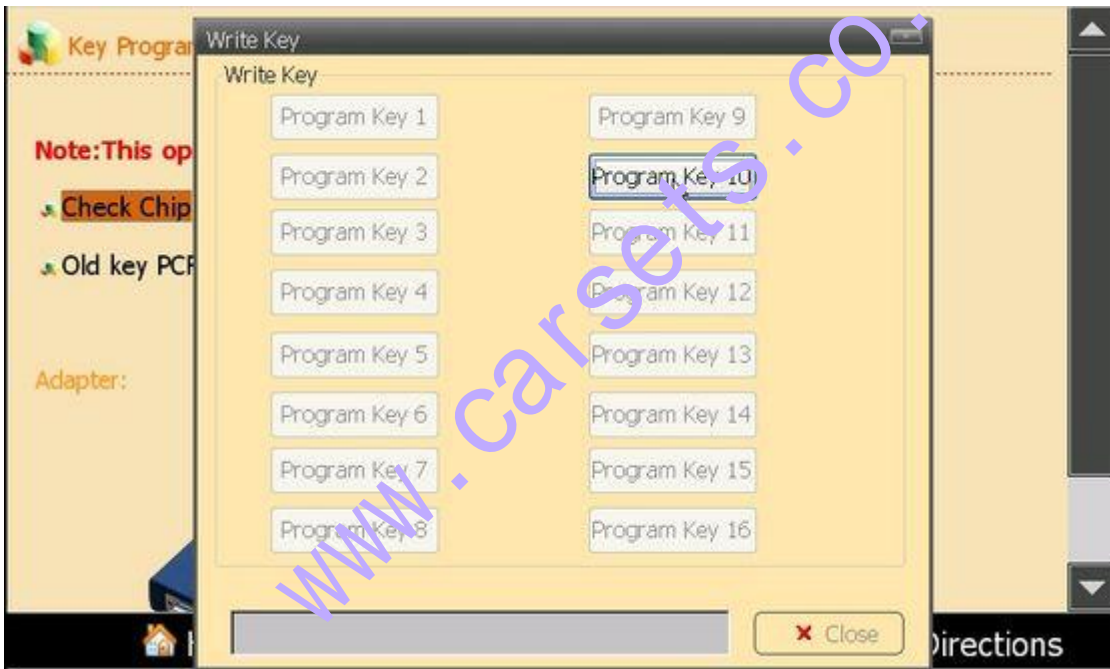

Step 6: During the programming process it will prompt you the quantity of the used key and the key can be bond, click "OK". When the used key has reached to 20, the key storage area was full, you need to go to the management center to update key list, please refer to *7.4 Reading Key List*

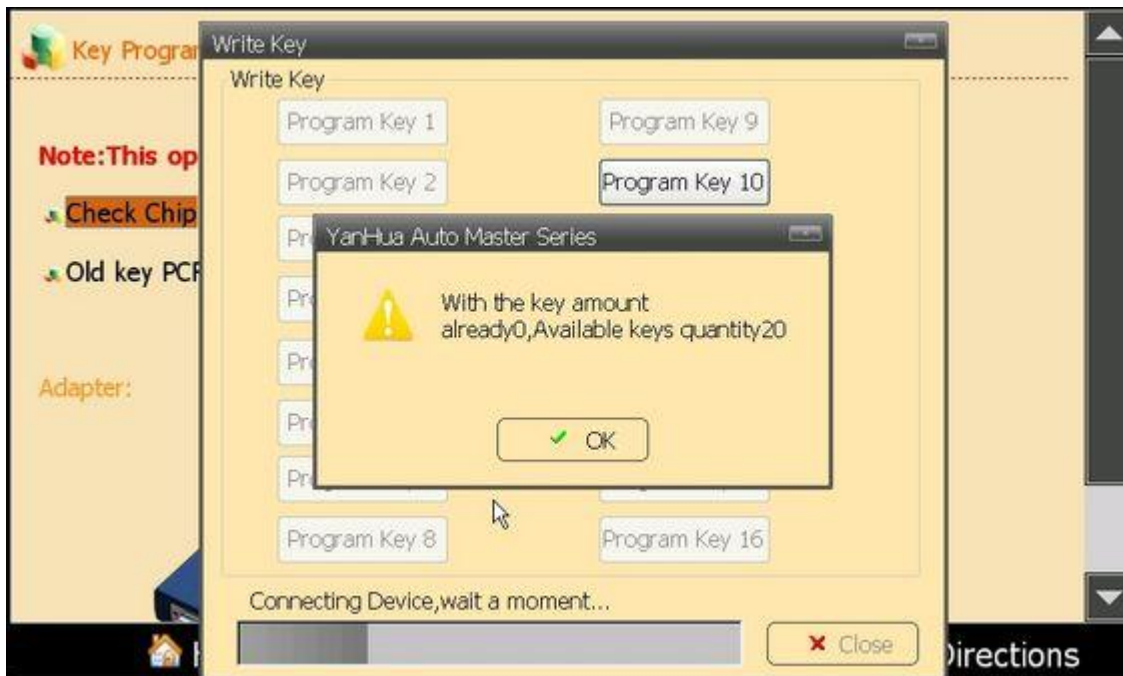

Step 7: Connect the 9S12 adapter to Digimaster III, click "Step 3: CAS programming" to write the data back to the CAS.



 If your BMW key was successfully programmed once, and you want to change to another key No. or another car, please contact our Technical department.

5. Airbag Resetting System

After airbag detonation, the error record will be saved in the memory code of circuit board by airbag ECU. If you write the data generated before detonation when the computer hard disk not destroy, then you no need to change the circuit board.

5.1 Airbag Resetting

Step1: Enter the Airbag Resetting interface, choose the relevant model. Here we take Toyota as example.



Step2: The airbag will be showed in list by number. Take "Toyota09170-06340" as example, you can find out the chip in airbag ECU according to the diagram, then dismantle the chip to install to OBP Adapter, click "next step" to go.



Step3: After finish reading data, it will prompt you whether need to restore airbag. Click "next step", the data will be restored to airbag chip.



6.Control Computer

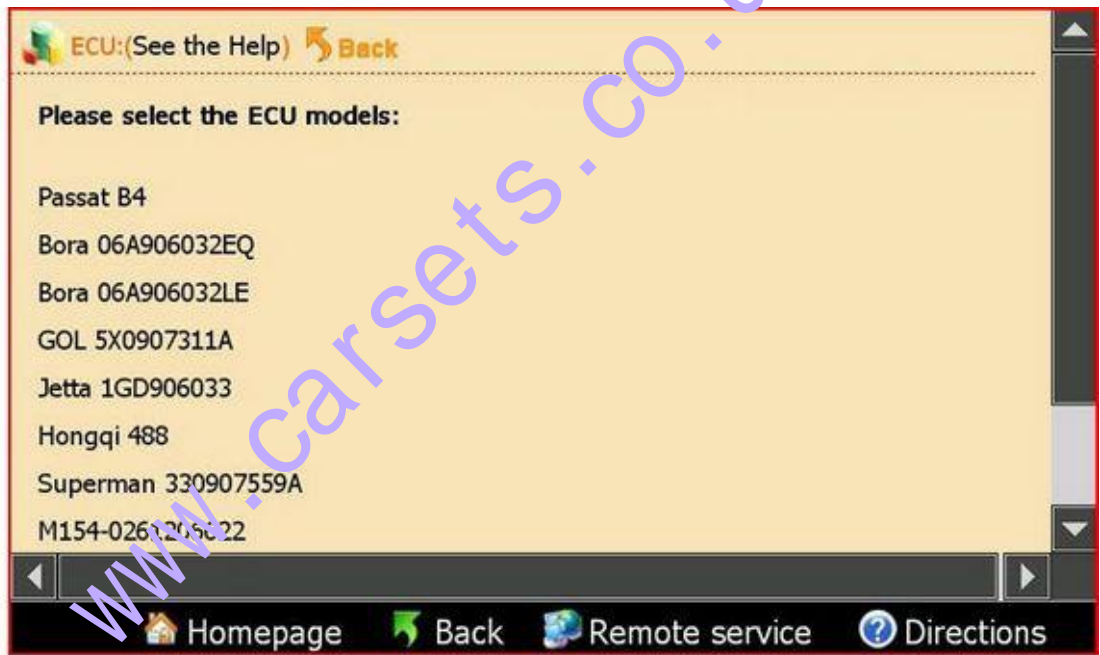

6.1 Resetting the Control Computer Data

Step1: Choose car model. Take "Passat B4" for example.

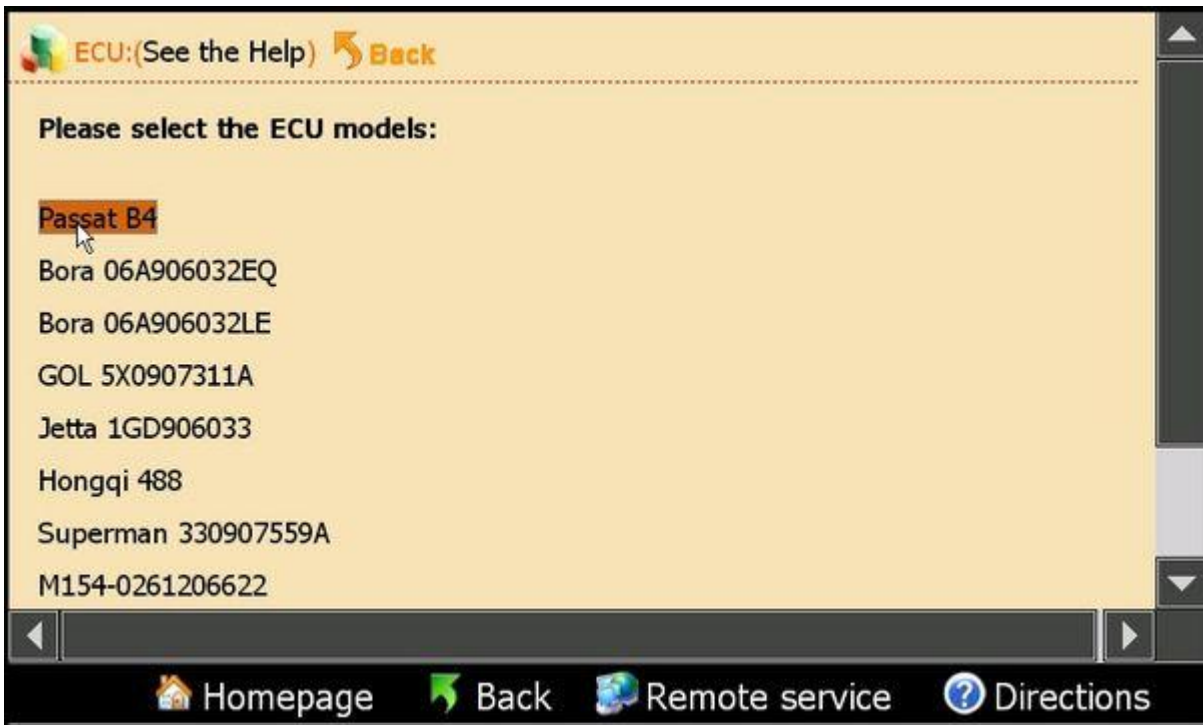

Step2: According to the diagram, dismantle the chip and install to ICP Adapter, click "next step" to go on.

Step3: After finish reading data, it will prompt that "it will cover the engine computer data", then click "next step" to write data into the engine computer.

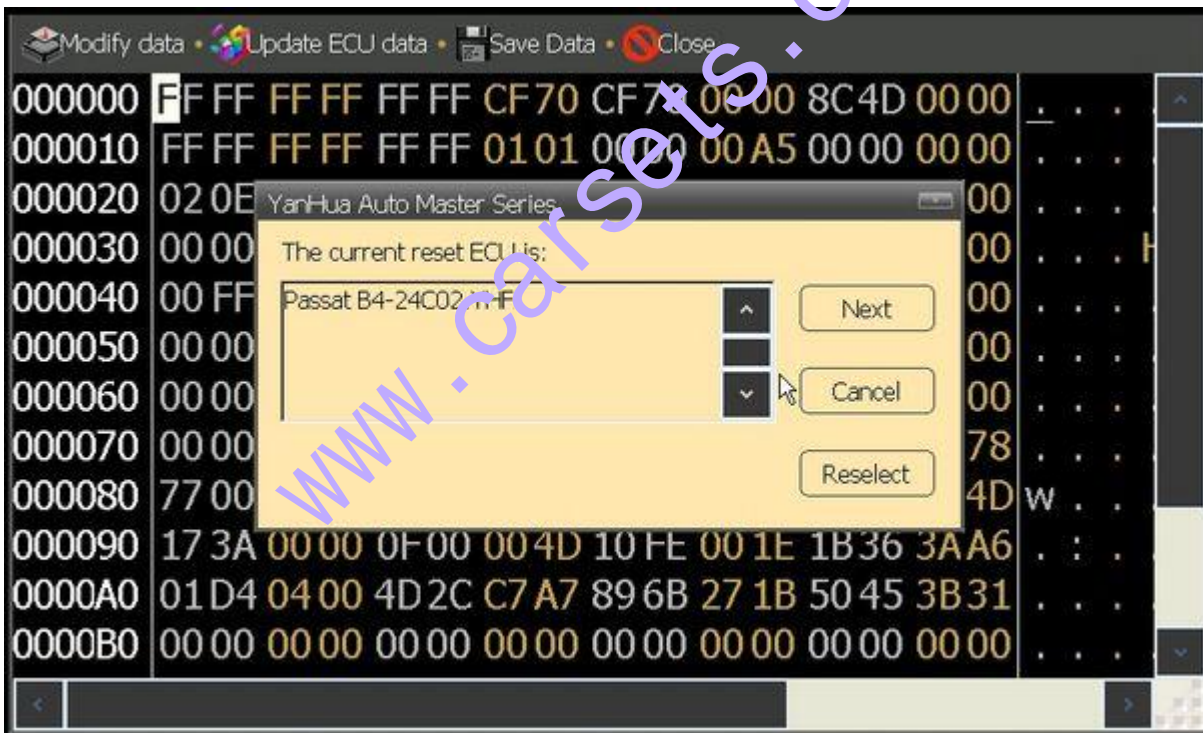

Step4: After all these operations, just need to put the chip back to car.

7.Management Center



7.1 Software Update

Click "Update" --- "Software Update";



As for the details of update steps, please refer to "3 Up-guide"

7.2 Adapter Update

Step1: Click "Update"---"Software update"

Step2: In "Usual Adapter" list, there are adapters needed to be updated in Odometer Adjustment and Airbag Resetting.

Step3: Mark the box of needed adapter, click "Upgrade" button. It will pop-up a box if the interface need to be converted to upgrade state in upgrading adapter. Please click "Pictures" to check how to convert the switch to upgrade state. Click "OK" to start to upgrade adapter.

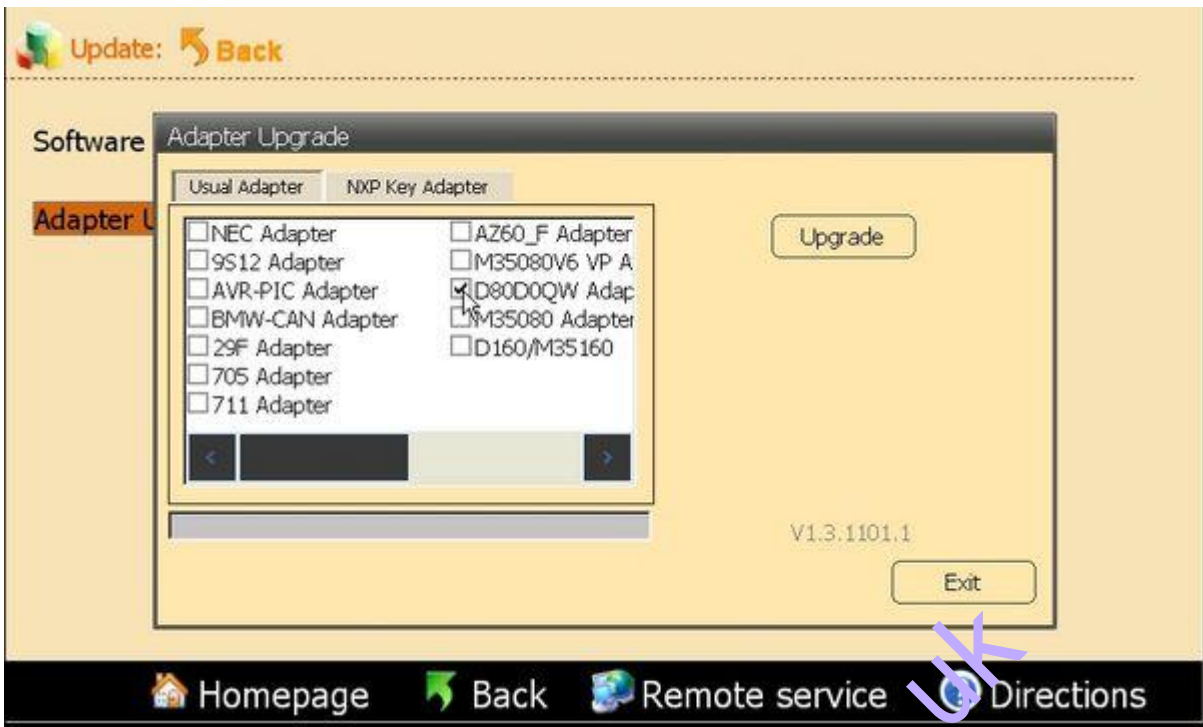

Tip : Convert to "NXP Adapter" upgrade icon to upgrade the NXP Adapter.

7.3 Key Register

Download and update your YH key List.



As for more operation details, please refer to "Demo"---"IMMO"---"Key Binding System"---"Key Binding".



7.4 Reading Key List

Reading the key ID bound to your device.



It will prompt you upgrade before reading key list, the steps are the same as the software upgrade. If you have done software update in recent days, please click "No" to skip this step.





Benz key information



BMW key information

7.6 Authorise

You can buy certain function model to use permanently through authorise card.



Step1: Click "Authorise" and enter validate code, and click "Next" to go on.



Step2: Enter the authorise card number and password which sellers sent you, then click "Next" to complete the authorise.

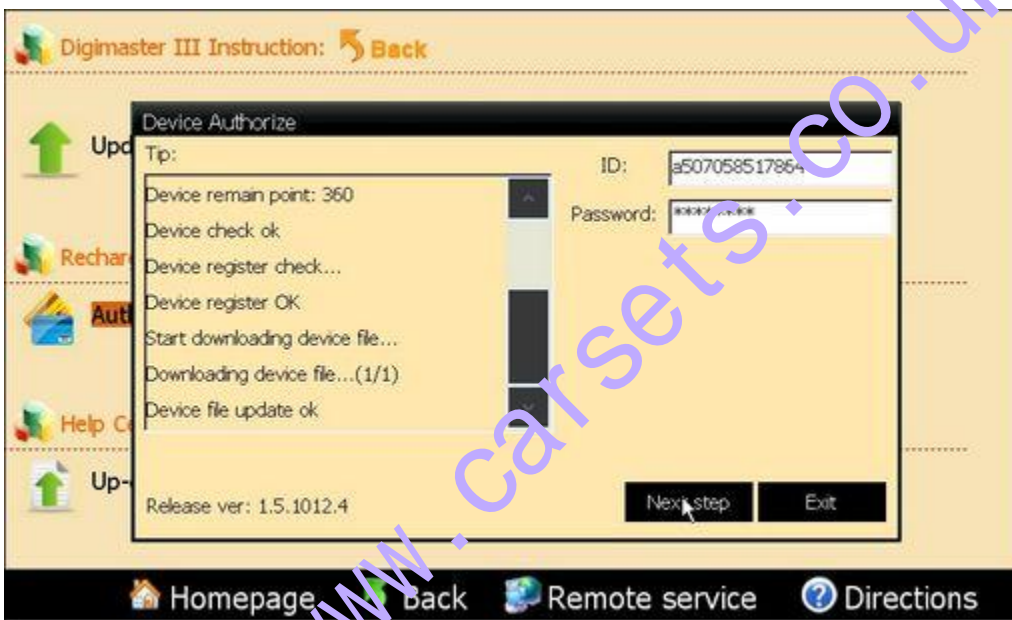

7.7 Module Price List

List the authorise module you bought. You also can buy authorise module in this list by yourself.



Step1: It will prompt you upgrade before reading module price list, the steps are the same as the software upgrade. If you have done software update in recent days, please click "No" to skip this step.



Step2: The module price list will show as follows. You can see the amount of authorise module you chose and the remain tokens in the lower-left corner. If you just want to see what it looks like when you chose the authorise module, please "Back" to exit.



Step3: If you want to buy the authorise module, please mark in the box and click "purchase now". A dialog box will pop up and show the module list you chose, then click "Next" to go on.

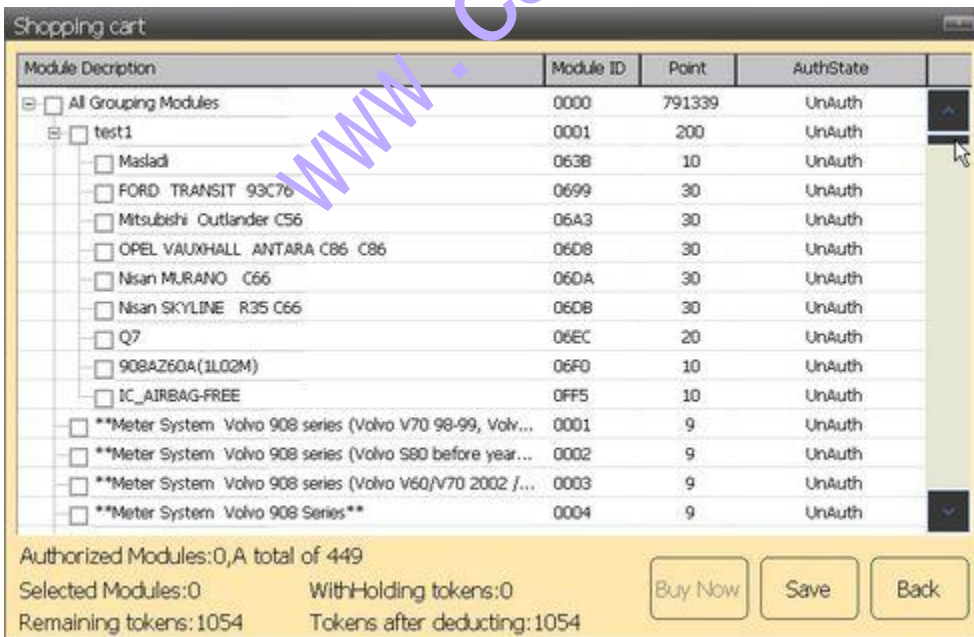

Step4: System will connect server automatically. Enter validate code and click "Next", you will buy the module successfully.

7.8 Remote Assistance

Through Internet, our engineer will do remote assistance for your D3 to help you when needed.



Step1: Make sure your D3 has connected to internet.

Step2: Contact with us, we will give you an IP number.

Step3: Click "Ask For Remote Assistance", enter the IP number in the pop-up box, and "OK".



7.9 Stylus Proofreading

If there are some location deviation when you touch screen, please use this function to do stylus proofreading.



Carefully press and briefly hold stylus on the center of the target.
Repeat as the target moves around the screen.
Press the Esc key to cancel.

www.carsets.co.uk

Appendix

Appendix2 Adapter Introduction

Picture	Product Name	Available Model
---------	--------------	-----------------

	<p>OBP Adapter</p>	<p>Applicable to EEPROM meter, airbag ECU, audio, ECU which need to be unsoldered.</p>
	<p>ICP Adapter</p>	<p>Applicable to free stitches of 93 series, 25 series, 35080 EEPROM, CPU meter, airbag ECU, audio, ECU, etc.</p>
	<p>NEC Adapter</p>	<p>Applicable to CPU free switch connecting of NEC series.</p>
	<p>35080 V6 Adapter</p>	<p>For 35080 series IC reading and writing</p>
	<p>NEC 14-PIN cable</p>	<p>Use together with NEC Adapter, applicable to CPU free switch connecting of NEC series.</p>
	<p>W203/W220 Adapter</p>	<p>Applicable to EIS ECU module programming of Mercedes-Benz C/S class electronic chassis W203/W220. Available model: 1.W220 EIS(08AZ60/1J35D)EIS(08AS60/4J74Y) 2.W215 EIS(08AZ60/1J35D)EIS(08AS60/4J74Y) 3.R230 EIS(08AZ60/1J35D)EIS(08AS60/4J74Y) 4.C CLASS W203 EIS(08AZ60/1J35D)</p>
	<p>TMS370 Programmer</p>	<p>Applicable to anti-theft reading for old Jetta, audio decoding for Deco and Opel.</p>

	<p>MCU Adapter</p>	<p>Applicable to MCU meter of China model. The MCU chip can be 12F629, ATMEGA16L, ATMEGA8L, etc.</p>
	<p>K&CAN Adapter</p>	<p>Applicable to airbag resetting via K-Cable for VW & Audi, CAS module programming for BMW.</p> <p>Applicable to the new BMW:</p> <ol style="list-style-type: none"> 1.CAS2 X5(E70)9S12DG256; 2.CAS2 1 ser white shell 9S12DG256; 3.CAS2 1 ser black shell 9S12DG256; 4.CAS2 3 ser white shell 9S12DG256; 5.CAS2 3 ser black shell 9S12DG256; 6.CAS2 5 ser white shell 9S12DG256; 7.CAS2 5 ser black shell 9S12DG256; 8.CAS2 6 ser white shell 9S12DG256; 9.CAS2 6 ser black shell 9S12DG256; 10.7 ser (F66)9S12DG256; 11.CAS3 X5 (E70)9S12XDP512; 12.CAS3 X6(E71)9S12XDP512; 13.CAS3 1 series 9S12XDP512; 14.CAS3 3 series 9S12XDP512; 15.CAS3 5 series 9S12XDP512; 16.CAS3 6 series 9S12XDP512
	<p>CAN-OBD DMI</p>	<p>Applicable to process of some Audi A6L & A8L.</p>
	<p>VW AUDI OBDII</p>	<p>Applicable to OBD adjustment for VW, Audi, Benz & BMW.</p>
	<p>BENZ 38PIN</p>	<p>Applicable to free switch adjustment for Benz S Class (before Year1999)</p>

	<p>BENZ OBD</p>	<p>Applicable to free switch adjustment for Benz SLK Class (before Year2000)</p>
	<p>BMW E36</p>	<p>Applicable to free switch adjustment for BMW E36</p>
	<p>BMW E36 Meter Socket Connecting Cable</p>	<p>Applicable to meter adjustment with socket connect cable for BMW E36</p>
	<p>BMW E38/39</p>	<p>Applicable to meter adjustment with socket connect cable for BMW E38/E39</p>
	<p>BENZ 95S</p>	<p>Applicable to meter adjustment with socket connect cable for Benz S Class, Year1995</p>
	<p>JAGUAR11DU</p>	<p>Jaguar meter socket connecting cable</p>

	<p>C/E CLASS</p>	<p>Applicable to meter adjustment with socket connect cable for Benz C & E Class, Year2000-2005</p>
	<p>Ford Ranger</p>	<p>Applicable to Ford Ranger.</p>
	<p>9S12 Adapter</p>	<p>Applicable to CAS ECU module programming for BMW 3/5/7 series of electronic chassis E90/E60/E66 (after 2005), and EIS ECU module programming for Mercedes-Benz C/E/C class of electronic chassis W220/W211/W203(after 2005)</p> <p>Available Model</p> <ol style="list-style-type: none"> 1.W220 EIS 912DG128/0K50E (9-112) 2.W220 EIS 912DG128A/3K91D (9-112) 3.W220 EIS 912DC128A/3K91D (9-112) 4.W220 EIS 9S12DG128/1L85D (9S80) 5.W215 EIS 912DG128/0K50E (9-112) 6.W215 EIS 912DG128A/3K91D (9-112) 7.W215 EIS 912DC128A/3K91D (9-112) 8.W215 EIS 9S12DG128/1L85D (9S80) 9.R320 EIS 912DG128/0K50E (9-112) 10.R320 EIS 912DG128/3K91D (9-112) 11.R320 EIS 912DC128A/3K91D (9-112) 12.R320 EIS 9S12DG128/1L85D (9S80) 13.W211 EIS 912DG128/0K50E (9-112) 14.W211 EIS 912DG128/3K91D (9-112) 15.W211 EIS 912DC128A/3K91D (9-112) 16.W211 EIS 9S12DG128/1L85D (9S80) 17.W209 EIS 912DG128/0K50E (9-112) 18.W209 EIS 912DG128/3K91D (9-112) 19.W209 EIS 912DC128A/3K91D (9-112) 20.W209 EIS 9S12DG128/1L85D (9S80) 21.W219 EIS 912DG128/0K50E (9-112) 22.W219 EIS 912DG128/3K91D (9-112) 23.W219 EIS 912DC128A/3K91D (9-112) 24.W219 EIS 9S12DG128/1L85D (9S80) 25.Old BMW EWS4 26.CAS1 7 series 912DG128A(3K91D)9-112 27.CAS1 7 series 912DG128(0K50E)9-112 28.CAS2 X5(E70)9S12DG256 29.CAS2 1 ser white shell 9S12DG256

		<p>30.CAS2 1 ser black shell 9S12DG256</p> <p>31.CAS2 3 ser white shell 9S12DG256</p> <p>32.CAS2 3 ser black shell 9S12DG256</p> <p>33.CAS2 5 ser white shell 9S12DG256</p> <p>34.CAS2 5 ser black shell 9S12DG256</p> <p>35.CAS2 6 ser white shell 9S12DG256</p> <p>36.CAS2 6 ser black shell 9S12DG256</p> <p>37.7 series (E66)9S12DG256</p>
	Lexus LS400 Adapter	Applicable to odometer IC(457C) of LexusLS400(1992-1994)
	Grand Cherokee Adapter	Applicable to odometer CPU of Grand Cherokee
	W211 Adapter	Applicable to process of EIS ECU module for Benz E Class W221(2002-2005)
	E65/E66 Adapter	Applicable to process of CAS ECU module for BMW 7 series E65/E66(2002-2004)
	CAS-BDM Programmer	<p>Applicable to process of EIS ECU module for BMW 3/5/7 series E90/E60/E66(after 2005)</p> <p>Available model</p> <ol style="list-style-type: none"> 1.W220 EIS 9S12DG128/1L85D (9S80) 2.W215 EIS 9S12DG128/1L85D (9S80) 3.R320 EIS 9S12DG128/1L85D (9S80) 4.W211 EIS 9S12DG128/1L85D (9S80) 5.W209 EIS 9S12DG128/1L85D (9S80) 6.W219 EIS 9S12DG128/1L85D (9S80)
	BMW CAN Adapter	Applicable to process of CAS ECU module (odometer socket)for BMW 3/5/7 series E90/E60/E66(after 2005)

	<p>MC705-PROG Adapter</p>	<p>1.S Class W140 DAS IMMO ECU 05X32(0D69J) 2.S Class W140 DAS IMMO ECU 05X32(0D53J/0D62J) 3.S Class W220 EIS ignition module 05X32(1D69J) 4.CLK Class W208 EIS ignition module 05X32(1D69J) 5.C Class W202 EIS ignition module 05X32(1D69J) 6.E Class W210 EIS ignition module 05X32(1D69J) 7.ML Class W163 AAM 05X32(G47V/1D69J)</p>
	<p>MC711-PROG Adapter</p>	<p>Old BMW EWS2(2D47J,0D46J)/EWS3(2D47J,0D46J)©</p>
	<p>NEC KEY</p>	<p>Mercedes Benz C, C, E, SL, CL, CLK and CLS Class Key</p>
	<p>EWS_K</p>	<p>adjust EWS through K line</p>
	<p>MC705E6</p>	<p>1.MOTOROLA key chip 2.E Class W210 ESL(05E6/G72A) 3.E Class W211 ESL(05E6/0F82B) 4.CLK Class W208 ESL(05E6/G72A) 5.CLK Class W209 ESL(05E6/0F82B) 6.CLS Class W219 ESL(05E6/0F82B) 7.C Class W202 ESL(05E6/G72A) 8.C Class W203 ESL(05E6/0F82B)</p>
	<p>CAS OBD II</p>	<p>BMW 7 series E65 before 2006</p>
	<p>NXP</p>	<p>7936,7941,7942,7943,7944,7946,7947,7952,7961</p>

	IAR key	Benz
	ESL	1.MOTOROLA key chio; 2.E Class W210 ESL(05E6/G72A); 3.E Class W211 ESL(05E6/0F82B); 4.CLK Class W208 ESL(05E6/G72A); 5.CLK Class W209 ESL(05E6/0F82B); 6.CLS Class W219 ESL(05E6/0F82B); 7.C Class W202 ESL(05E6/G72A); 8.C Class W203 ESL(05E6/0F82B);
	29FXX	Old Mercedes Benz DME Chip

Appendix3 Replaced Chip List

Original Chip	Replaced Chip	Remark
93C06	93C46	93C06 cannot replace 93C46
9314	93C46	9314 cannot replace 93C46
C46M6	93C46	
DD72	93CS66	DD72 cannot replace 93CS66
DD82	93CS66	DD82 cannot replace 93CS66
S220	93CS66	S220 cannot replace 93CS66
93C56	93C66	93C56 cannot replace 93C66
C56M6	93CS66	C56M6 cannot replace 93CS66
CS56	93CS66	CS56 cannot replace 93CS66
85C72	24C16	85C72 cannot replace 24C16
85C82	24C16	85C82 cannot replace 24C16
24C01	24C16	24C01 cannot replace 24C16
24C02	24C16	24C02 cannot replace 24C16
24C04	24C16	24C04 cannot replace 24C16
24C08	24C16	24C08 cannot replace 24C16
D6253	24C16 or 24C01	D6253 cannot replace 24C16

D6254	24C16 or 24C01	D6254 cannot replace 24C16
PDH001	X2444P or X24C44	
PDH004	X2444P or X24C44	
X24C01	no	X24C01 & 24C01 cannot replaced each other

Appendix4 Chip Dismantling and Soldering

I. Chip Dismantling and Soldering:

1 The choice of iron:

It should be connected with ground safely. When there is no constant temperature soldering iron, the 20W internal heat-type or 25W external heat-type soldering iron can be OK, but ensure that the former should not exceed 25W, and the latter does not exceed 30W.

2 The choice of flux:

Rosin is the best choice. Solder paste will never be allowed to use in soldering. You should change the rosin immediately when it turns to black.

3 The choice of solder wire:

The imported solder wire with low melting point and rosin is the only choice

II. Chip disassembling

1. When unsoldering biserial & straight inserted chip, you can clean out the soldering tin on the pin by disordering gun or disordering wire, please don't draw hard.

2. When unsoldering patch or chip, melting more rosin on the two rows of pins, and heat them up until the chip loose completely, then remove it. Please don't pry hard.

3. Please do not heat the chip too long, or it will be damaged.

4. If there is protection paint on the chip, please heat it up with iron, and scratch gently with a blade or tweezers, then dismantle the chip.

5. How to wipe off the protection paint on the circuit board or IC? Before soldering, please heat the layer of protection paint with iron or hot air to 70-80 degrees Celsius, and then peel gently with a word screwdriver.

III. Chip Soldering

1. Please do not heat the chip too long, or it will be damaged.

2. The iron should be wiped with a damp cloth or soaking sponge to keep it clean, because it won't be easy to disordering tin in a state of high-temperature oxidation for a long time.

3. The heat conduction should depend on the tin, and it does no good to soldering by the iron head-to-chip hard.

4. Don't move or shake the chip before the soldering solidified.

5. When soldering, you had better first solder the diagonally pins to fasten the chip, and then do other pins.

www.carsets.co.uk